



PROMETNA OPREMA

Cestna oprema, kovinska oprema,
urbana oprema, varovalne in odbojne ograje

- I. Vertikalna prometna signalizacija
- II. Železniška prometna signalizacija, Vodne poti - znaki za urejanje plovbe
- III. Varnostni znaki, gradbiščne table, reklamne table in druge obvestilne table
- IV. Znaki za smučišča, planinske in pohodniške poti, znaki za označevanje naravnih vrednot in nepremičnih kulturnih spomenikov
- V. Prometna oprema**
- VI. Horizontalna signalizacija
- VII. Znaki po naročilu
- VIII. Oprema vozil
- IX. Spreji za označevanje
- X. Druge talne označbe

Cestna oprema, kovinska oprema, urbana oprema, varovalne in odbojne ograje

1. Cestna oprema	2
1.1 Stožci	2
1.2 Zapore	2
1.3 Luči utripalke	2
1.4 Oprema za delovišča	3
1.5 Cestni smerniki	3
1.6 Posode	4
1.7 Triopan znaki	4
1.8 Cestne pregrade	4
1.9 Hitrostne ovire	5
1.10 Parkirni omejevalci	5
1.11 Povožni stebrički	5
1.12 Ogledala	6
1.13 Gradbiščni semaforji	7
1.14 Stojala	7
2. Kovinska oprema	8
2.1 Pritrdilni elementi - objemke	8
2.2 Pritrdilni elementi - drugi pritrdilni elementi	9
2.3 Konstrukcije - prometni znaki	10
2.4 Konstrukcije - veliki prometni znaki	10
2.5 Lamele, klasična in pol portalna konstrukcija	11
2.6 Drog za znak - TIP S	12
2.7 Drog za znak - TIP L	18
2.8 Koreninski stebriček	19
2.9 Šablone	20
3. Urbana oprema	22
4. Varovalne in odbojne ograje	24



Cestna oprema

**PROMETNA
OPREMA V/1**

Cestna oprema, kovinska oprema,
urbana oprema, varovalne in odbojne ograje

1 - cestna oprema

1.1 - stožci



Stožci

mehak pvc (guma)
velikosti 20, 30, 50, 75 cm
trakovi: ne-odbojni, odbojni, H.I.
z ali brez podstavka



Stožci

trdi pvc
velikosti 30, 50, 75 cm
trakovi: ne-odbojni, odbojni, H.I.

1.2 - zapore



Tabla pokončne
zapore



podstavki



Garnitura utripajoče
luči (4-8) na tablah
pokončne zapore



Čelne zapore

1.3 - luči utripalke



Luči utripalke



Batarije

oprema za delovišča - 1.4



Opozorilne zastavice na vrvici, raztegljive zapore in zaščita jaškov

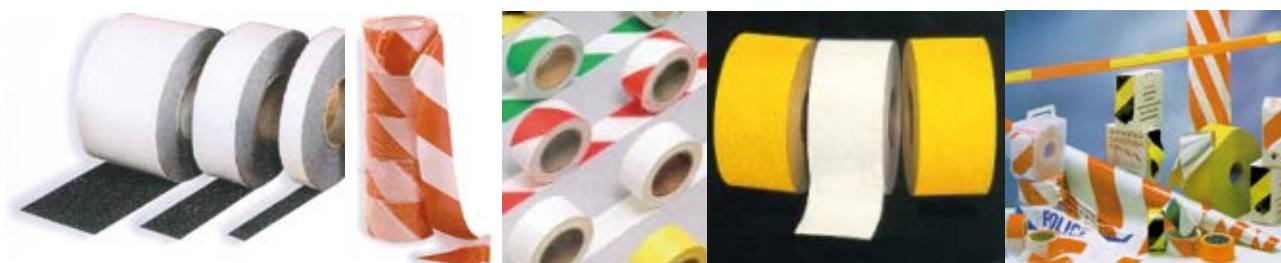

Trakovi za označbo delovišč

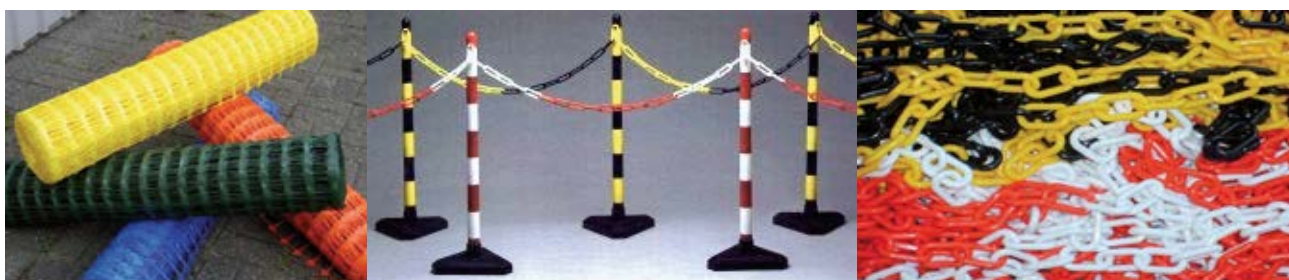

Zaščitne mreže in stebrički

cestni smernik - 1.5



1 - cestna oprema

1.6 - posode



Posode za pesek, posipalci, kontejnerji

1.7 - triopani znaki



odsevni in neodsevni
velikosti: 70, 90, 120 cm

1.8 - cestne pregrade

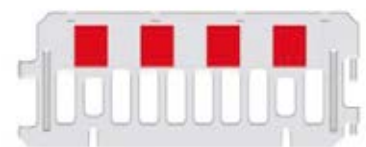

Za podrobnejše informacije pošljite povpraševanje na info@signaco.si
ali pokličite na tel. št. 01/723 09 73

hitrostne ovire - 1.9



hitrostna ovira tip 5
hitrostna ovira: 5 x 90 x 50 cm
teža: 20 kg
zaključek: 5 x 90 x 27 cm
teža: 6,5 kg



hitrostna ovira tip 7
hitrostna ovira: 7 x 120 x 50 cm
teža: 33 kg
zaključek: 7 x 120 x 30,7 cm
teža: 14,5 kg

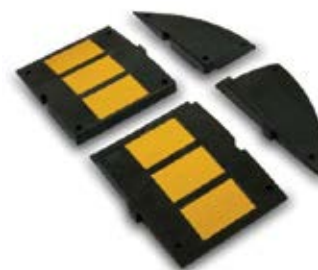

parkirni omejevalci - 1.10



povozni stebrički - 1.11

povozni stebriček
višina 82 cm
fi ~10 cm



povozni stebriček
višina 75 cm
fi ~20 cm



1 - cestna oprema

1.12 - ogledala



Dimenzije: fi 400, fi 500, fi 600,
fi 700, fi 800, fi 900



Dimenzije: fi 400, fi 500, fi 600,
fi 700, fi 800, fi 900



Dimenzije: fi 550, fi 750



Dimenzije: fi 600, fi 750,



Dimenzije: 600 x 400, 600 x 800,
700 x 900, 100 x 800



Dimenzije: 600 x 400, 600 x 800,
700 x 900, 100 x 800

gradbiščni semaforji - 1.13

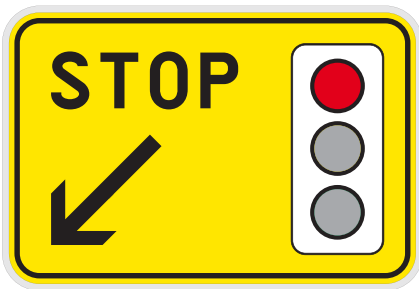

Pz Stop-R
Obvezna ustavitev pri rdeči luči
900x600 mm
600x400 mm



Akumulatorji za semaforje
180 Ah, 12 V



Gradbiščni semaforji

stojala - 1.14



Opozorilno stojalo
za mokra tla



Trinožno stojalo za znake,
višina 125 cm,
Fe-prašno barvano



Kovinska oprema

**PROMETNA
OPREMA V/2**

Cestna oprema, kovinska oprema,
urbana oprema, varovalne in odbojne ograje

2 - kovinska oprema

2.1 - pritrdilni elementi - objemke



Objemka za prometni znak
fi 63 mm, Alu



Dvojna objemka za prometni znak
fi 63 mm, Alu (sendvič sistem)



Objemka za prometni znak, drog JR,
fi 90/110/155 mm, Alu



Objemka za prometni znak, drog JR,
fi 90/110/155 mm, Fe-vročē cinkano



Enojna/dvojna objemka za lamele,
fi 60/63 mm, Alu



Objemka za lamele, drog JR,
fi 76 - 200 mm, Fe-vročē cinkano

pritrilni elementi - objemke - 2.1



Prikaz pritrditve objemke



Izdelamo vam tudi objemke za drogove JR drugačnih dimenzij / premerov



Dvojna objemka za lamele drog JR fi 76 - 200 mm, Fe-vročē cinkano

pritrilni elementi - drugi pritrilni elementi - 2.2



Vmesni element za podaljšek drogov fi 63 mm, Fe-vročē cinkano



Podporna objemka fi 63 mm, Fe-vročē cinkano



Nastavek za podstavek cevi 76 mm za drog fi 63 mm, Fe-vročē cinkano



Trinožno stojalo za znake, V= 125 cm, Fe-prašno barvano

lamelle, klasična in pol portalna konstrukcija - 2.5

Prikazana je max. višina

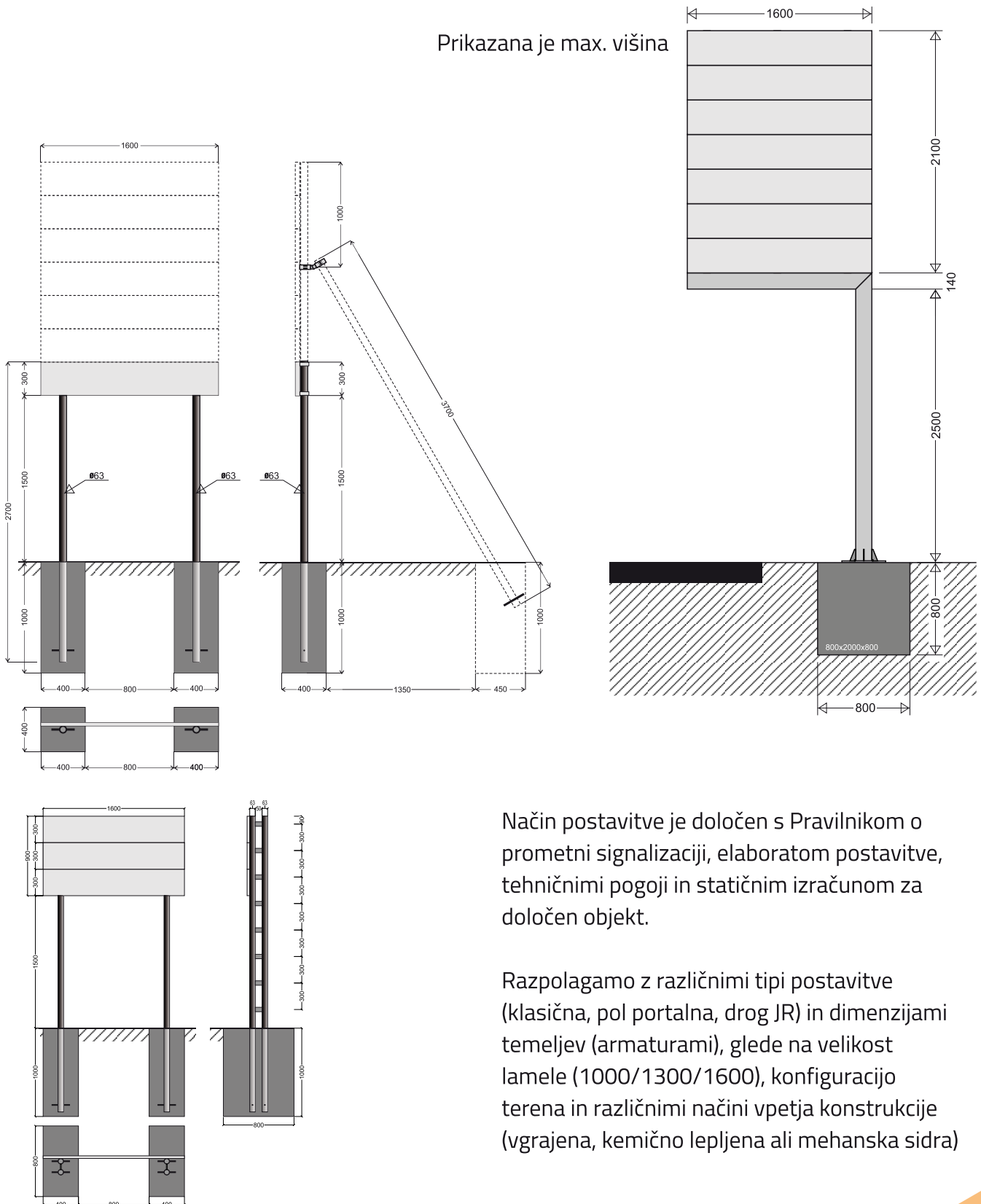

Način postavitve je določen s Pravilnikom o prometni signalizaciji, elaboratom postavitve, tehničnimi pogoji in statičnim izračunom za določen objekt.

Razpolagamo z različnimi tipi postavitve (klasična, pol portalna, drog JR) in dimenzijami temeljev (armaturami), glede na velikost lamelle (1000/1300/1600), konfiguracijo terena in različnimi načini vpetja konstrukcije (vgrajena, kemično lepljena ali mehanska sidra)

Drogovi tipa:

S-2500-300-A
 S-2500-300-B
 S-2500-300-C
 S-2500-300-D
 S-2500-300-E

A = 600 mm
 B = 900 mm
 C = 1000 mm
 D = 1200 mm
 E = 1400 mm

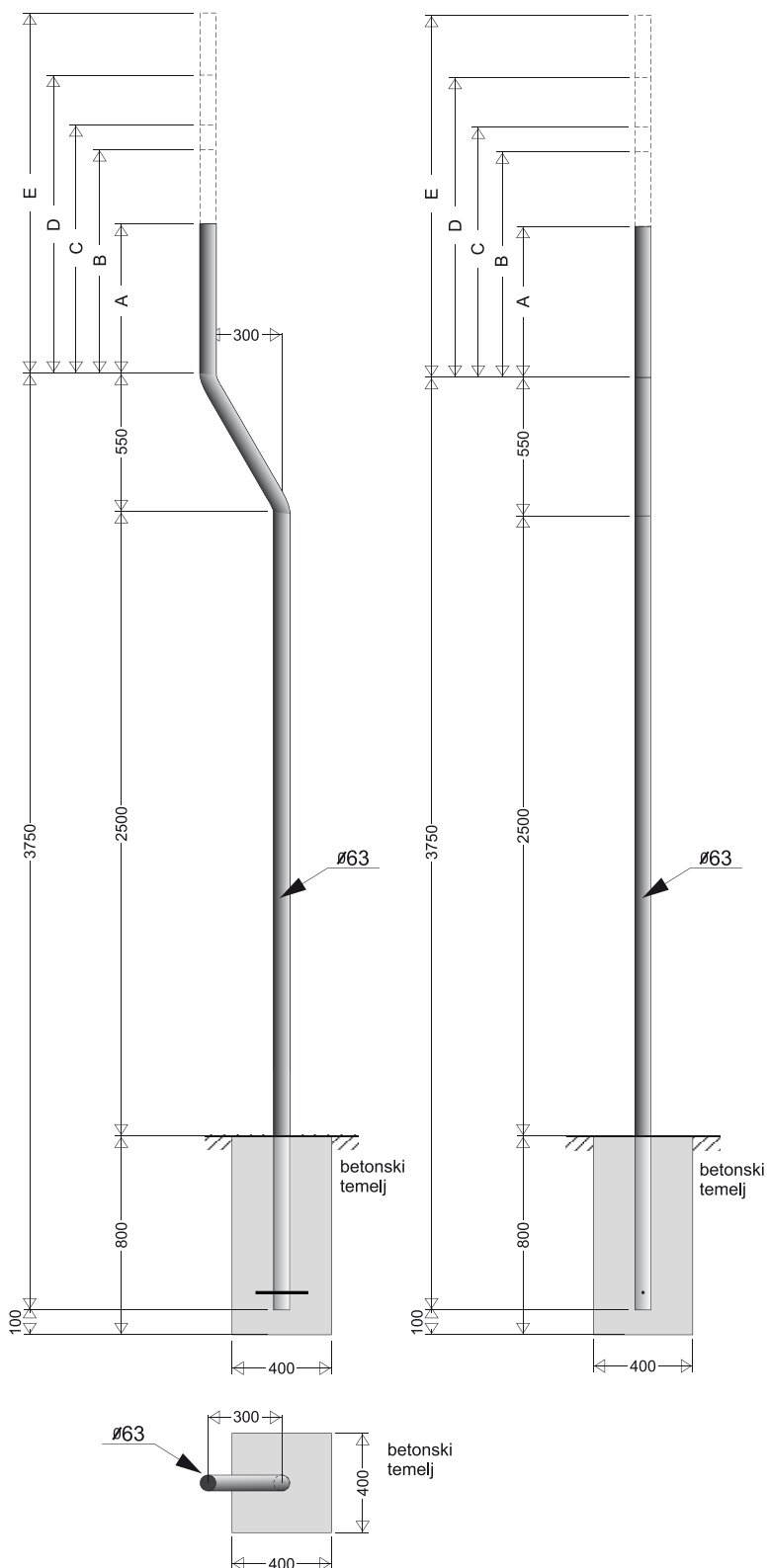

2 - kovinska oprema

2.6 - drog za znak - TIP S

Drogovi tipa:

- S-2250-400-A
- S-2250-400-B
- S-2250-400-C
- S-2250-400-D
- S-2250-400-E

- A = 600 mm
- B = 900 mm
- C = 1000 mm
- D = 1200 mm
- E = 1400 mm

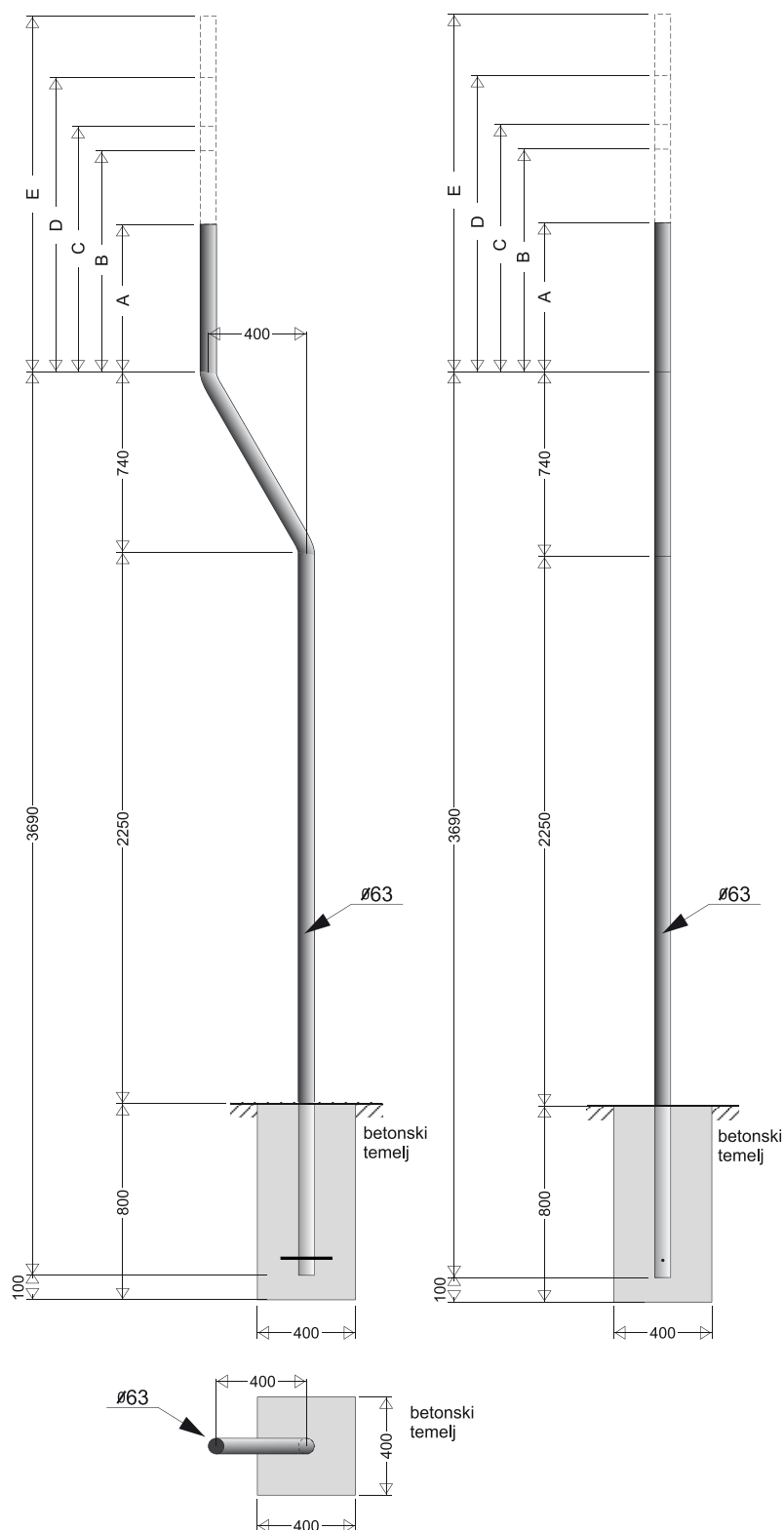

drog za znak - TIP S - 2.6

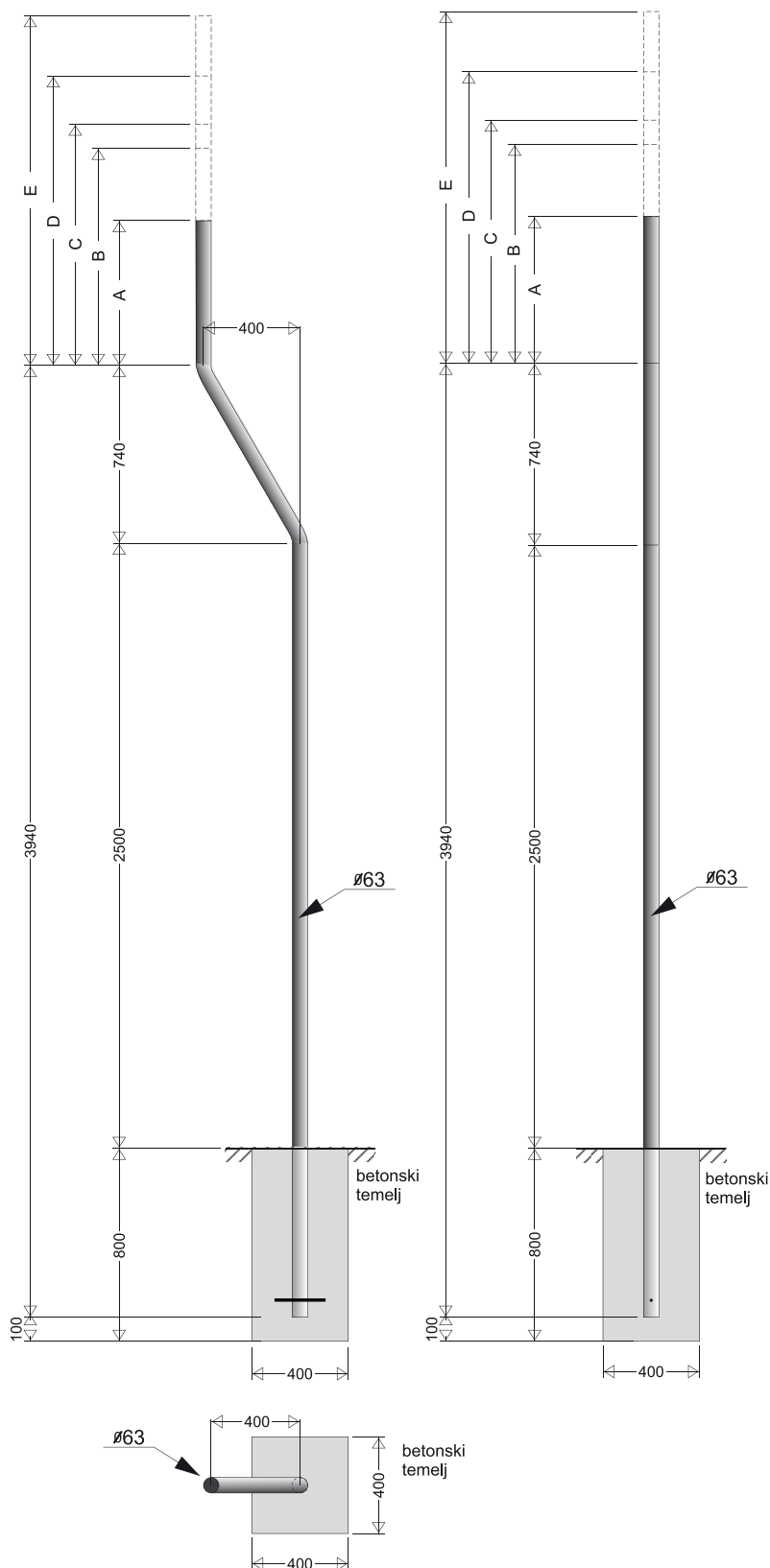

Drogovi tipa:

- S-2500-400-A
- S-2500-400-B
- S-2500-400-C
- S-2500-400-D
- S-2500-400-E

- A = 600 mm
- B = 900 mm
- C = 1000 mm
- D = 1200 mm
- E = 1400 mm

2 - kovinska oprema

2.6 - drog za znak - TIP S

Drogovi tipa:

- S-2250-500-A
- S-2250-500-B
- S-2250-500-C
- S-2250-500-D
- S-2250-500-E

- A = 600 mm
- B = 900 mm
- C = 1000 mm
- D = 1200 mm
- E = 1400 mm

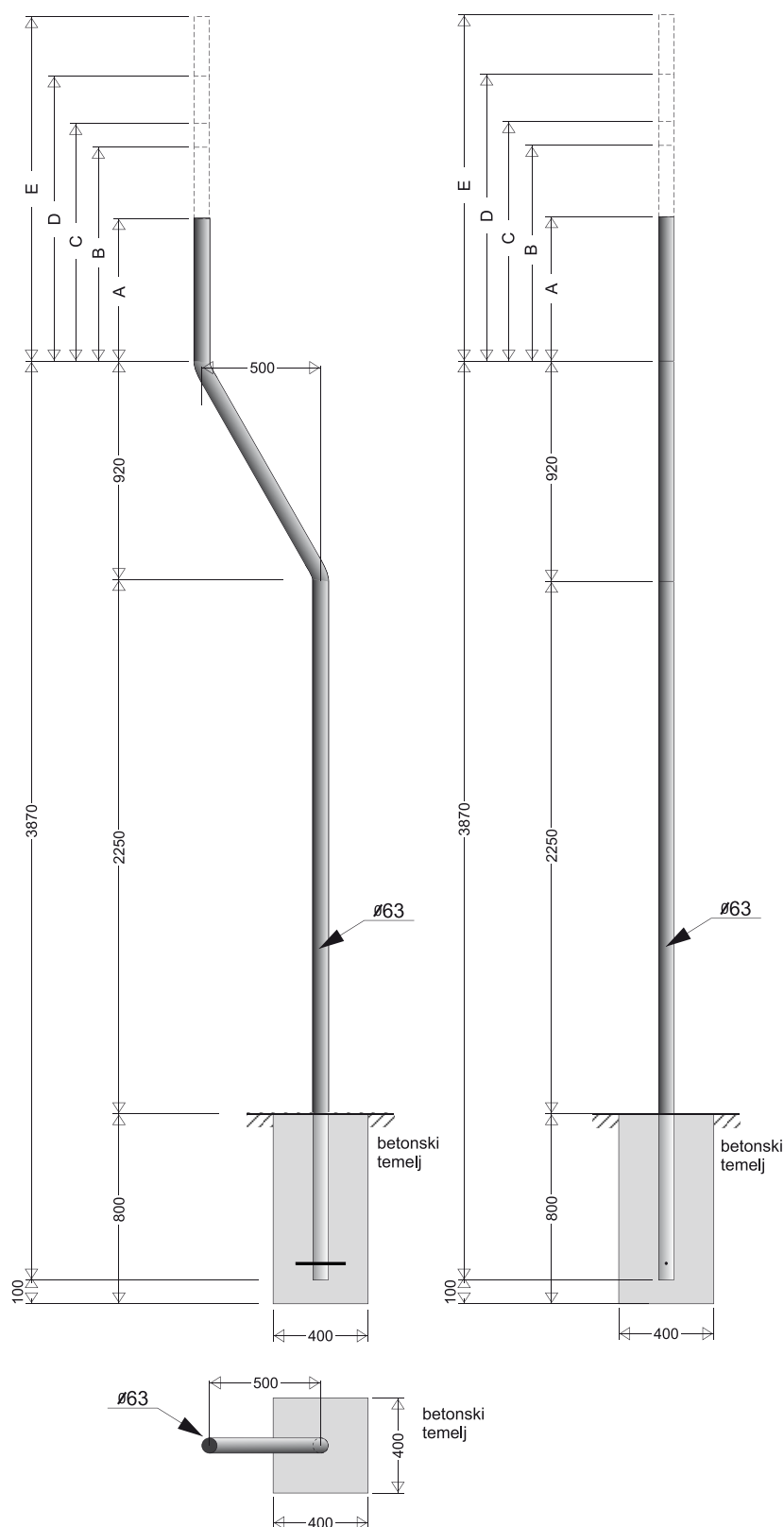

drog za znak - TIP S - 2.6

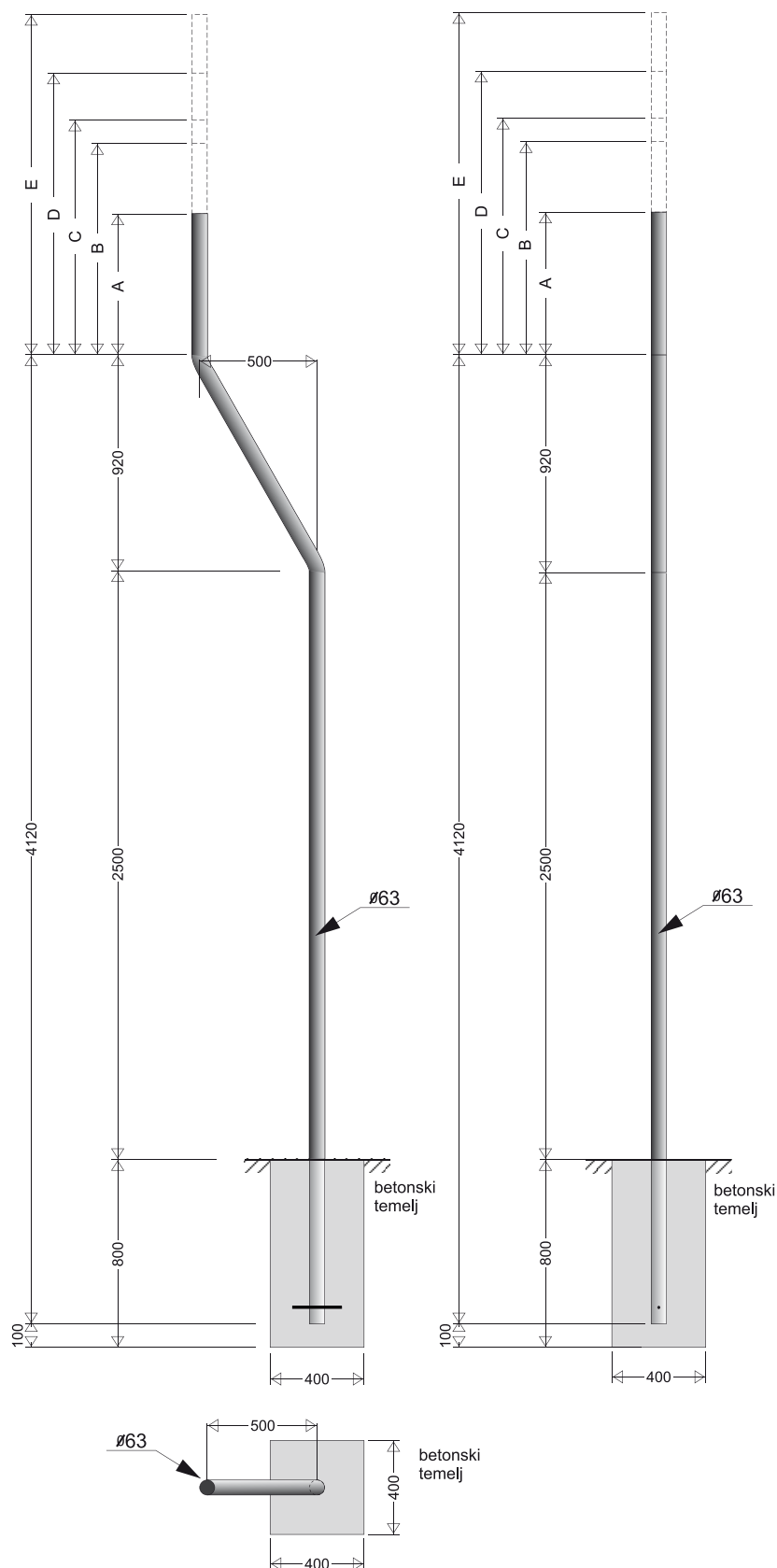

Drogovi tipa:

- S-2500-500-A
- S-2500-500-B
- S-2500-500-C
- S-2500-500-D
- S-2500-500-E

- A = 600 mm
- B = 900 mm
- C = 1000 mm
- D = 1200 mm
- E = 1400 mm

2 - kovinska oprema

2.7 - drog za znak - TIP L

Drogovi tipa L:

- L-2600-600
- L-2600-750
- L-2600-1000
- L-2600-1250
- L-2600-1500

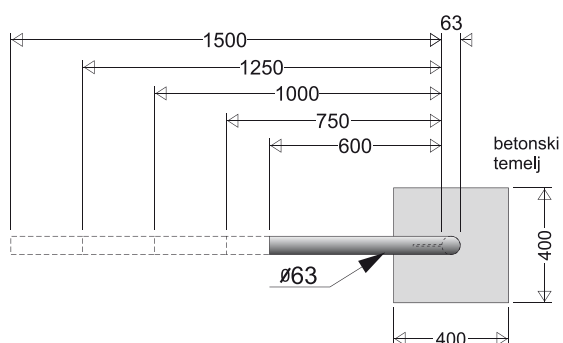
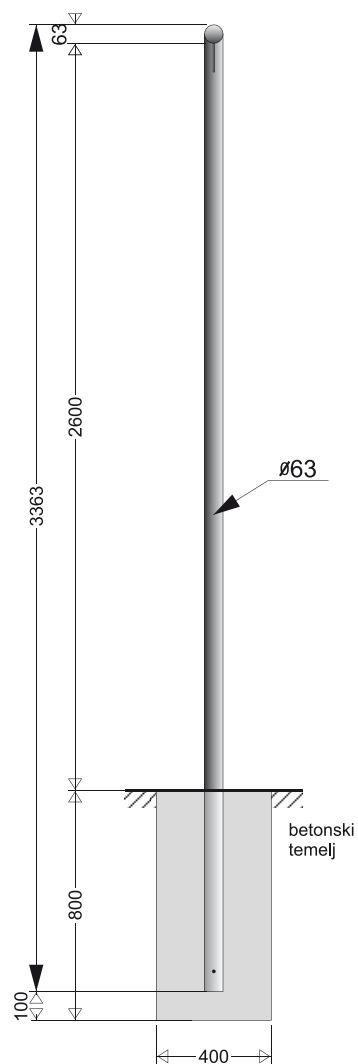
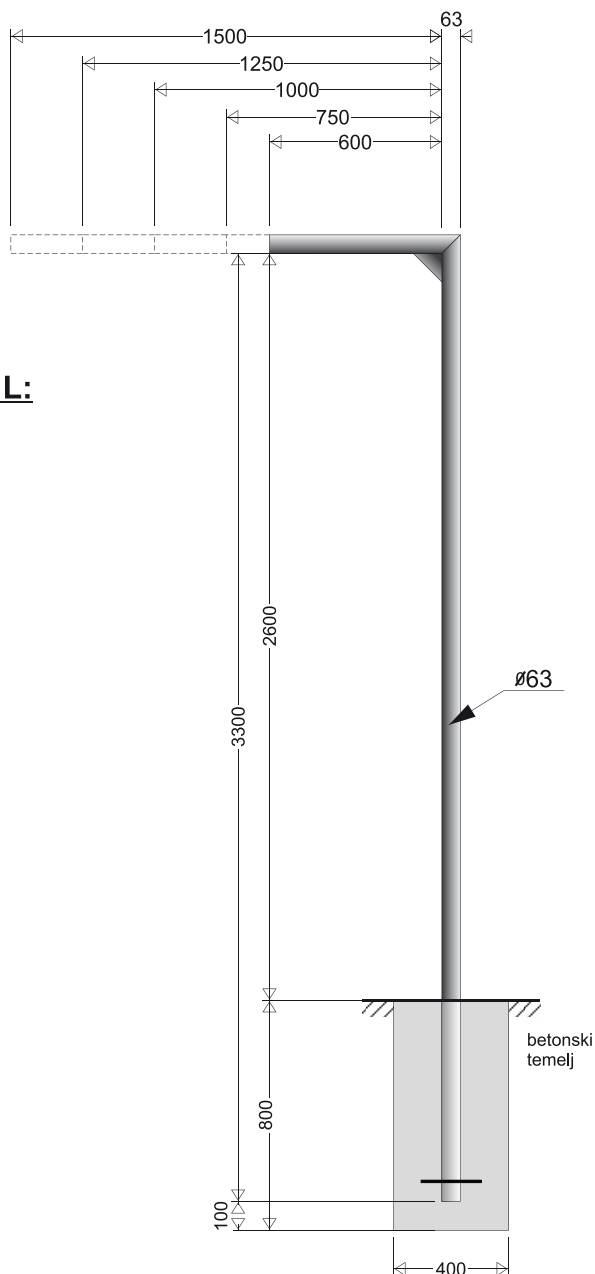

Max. velikosti pz pri ročici dolžine:

- L600** = fi 500 / 500 x 600 (š x v)
- L750** = fi 600 / 600 x 600 (š x v)
- L1000 do 1500** = fi 600 / paziti na odmik od tal do spodnjega roba pz je min. 225 cm nad površinah za pešce in kolesarje

koreninski stebriček - 2.8

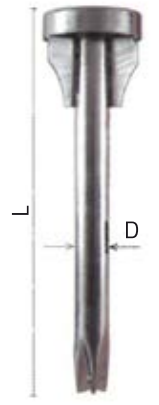
	(\varnothing) D diameter (" in mm)	L dolžina sidra (mm)	S krilci za povečano stabilnost	Šifra izdelka
	6/4 (48)	480	x	x
			s krilci	0680
	2 (60)	600	brez krilc	0145
			s krilci	0146
	480	brez krilc	0143	
s krilci		0679		
600	brez krilc	0151		
	s krilci	0147		

SIDRO	VIJAKI	PRITRDILNA PRIROBNICA (ŠIFRA: 6/4"= 0613, 2"= 0687)	ELESTIČNI KOVINSKI ZATIČ (ŠIFRA: 0658)	SESTAVLJENO SIDRO
				
ROZETA NERJAVEČA (ŠIFRA: 0684)	POKRIVNA PLOŠČICA (ŠIFRA: 0614)	ADAPTER ZA ZABIJANJE (ŠIFRA: 6/4"= 0658, 2"= 0688)	LIBELA	
				

Koreninski stebriček služi kot temelj za postavitev stebrov brez betoniranja, za stebre 6/4 cole (48 mm) ali 2 cole (60 mm).

Dolžina sidra je 600 ali 480 mm. Steber se v nosilni drog pritrdi s pritrdilno prirobnico, s tesnilnim vložkom (kovinski ali gumijast) in vijaki.

Primeren je tako za mehke travnate terene, kot tudi za utrjene asfaltirane ali betonirane površine. Od vrste tal je odvisna izbira dolžine sidra. Kjer želimo imeti povečano statično stabilnost (zelo mehki teren, parkirišča – pogoste prometne nesreče), uporabimo varianto sidra s krilci.

- za travnate terene se uporabi dolžina 600 mm
- za utrjene terene (parkirišča, pločniki, ceste,...) pa dolžino 480 mm
- za povečano statično stabilnost uporabimo sidra s krilci

2 - kovinska oprema

Šablone so lahko izdelane iz samolepilne folije za enkratno uporabo ali ALU pločevine za trajno uporabo. Dimenzije šablon/simbolov so poljubne oz. skladno s pravilniki. Prikazanih je nekaj primerov šablon, za več informacij pošljite povpraševanje na info@signaco.si.

2.9 - šablone

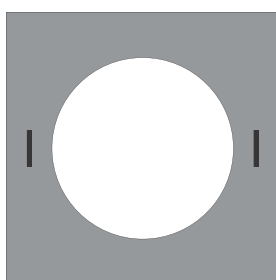

Šablona „**Talne oznake-varnostni znaki za obveznost**“
osnova širina 600 mm, višina 600 mm
simbol fi 400 mm



M008
Šablona „**Talne oznake-varnostni znaki za obveznost**“
širina 500 mm, višina 500 mm

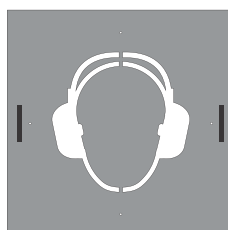

M003
Šablona „**Talne oznake-varnostni znaki za obveznost**“
širina 500 mm, višina 500 mm



M004
Šablona „**Talne oznake-varnostni znaki za obveznost**“
širina 500 mm, višina 500 mm



M015
Šablona „**Talne oznake-varnostni znaki za obveznost**“
širina 500 mm, višina 500 mm

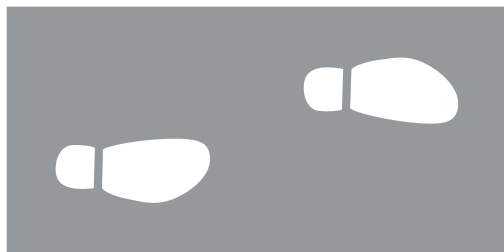

Šablona „**Nogice**“
širina 1000 mm, višina 500 mm
simbol širina 310 mm



Šablona „**Viličar**“
širina 1100 mm, višina 1000 mm
simbol višina 800 mm

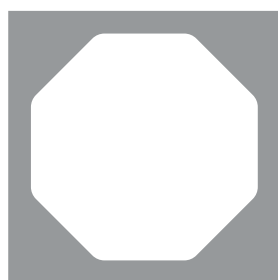

2102
Šablona „**Stop**“
širina 1200 / 1000 mm, višina 1200 / 1000 mm



Šablona „**Izhod**“
širina 1500 mm, višina 2000 mm
simbol širina 1000 mm



Urbana oprema

PROMETNA
OPREMA V/3

Cestna oprema, kovinska oprema,
urbana oprema, varovalne in odbojne ograje

3 - urbana oprema

urbana oprema

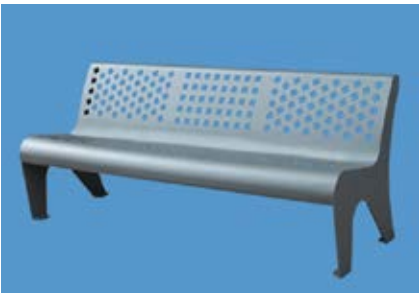

Za podrobnejše informacije pošljite povpraševanje na info@signaco.si





**PROMETNA
OPREMA V/4**

Varovalne in odbojne ograje

Cestna oprema, kovinska oprema,
urbana oprema, varovalne in odbojne ograje

4 - varovalne in odbojne ograje

varovalne in odbojne ograje



Za podrobnejše informacije pošljite povpraševanje na info@signaco.si

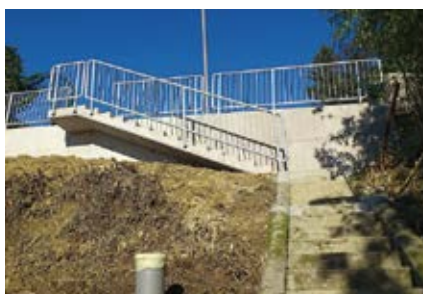



**Podjetje za proizvodnjo prometnih in
neprometnih znakov ter obvestil d.o.o.**

Topole 51/a, 1234 Mengeš

tel. +386 1 723 09 73

tel. +386 1 723 09 74

fax. +386 1 723 09 75

www.signaco.si

e-mail: info@signaco.si

